

REV.	ECN.NO.	MODIFY.CONTENT	DATE
A		NEW	2018/10/31

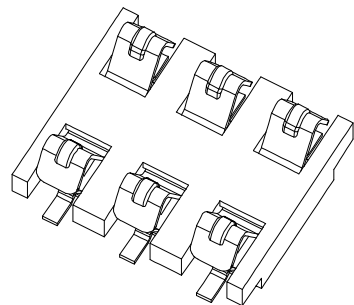

- NOTES:
- ELECTRICAL PERFORMANCES:
    - 1-1.RATING CURRENT:0.3A
    - 1-2.RATING VOLTAGE:30V AC
    - 1-3.CONTACT RESISTANCE:100mΩ
    - 1-4.INSULATION RESISTANCE:100MΩ
  - MECHANICAL PERFORMANCES:
    - 2-1.NORMAL FORCE AT MATING POSITION: 90g MIN PER PIN.
    - 2-2.OPERATION TEMPERATURE:-35°~+85°C

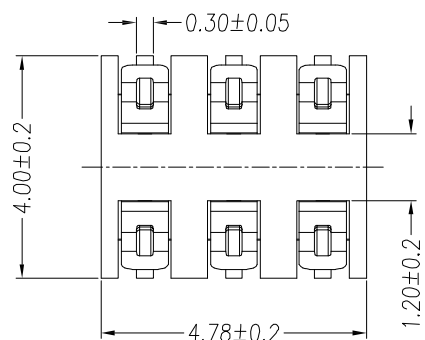
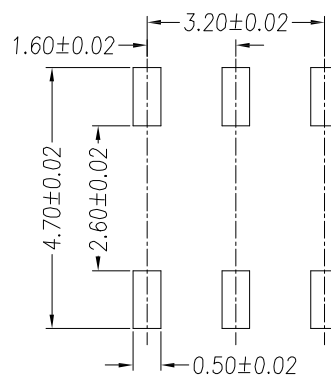
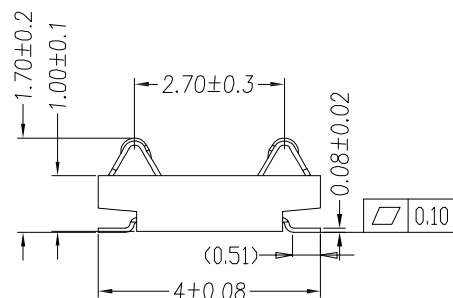
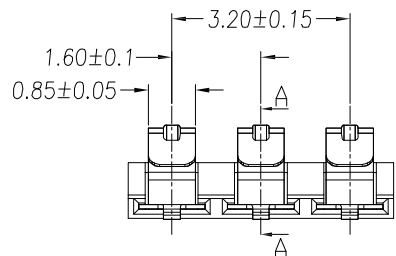
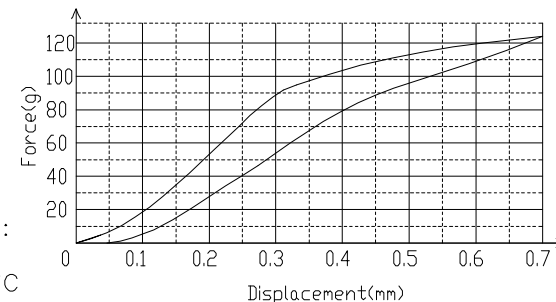

RECOMMENDED PCB LAYOUT

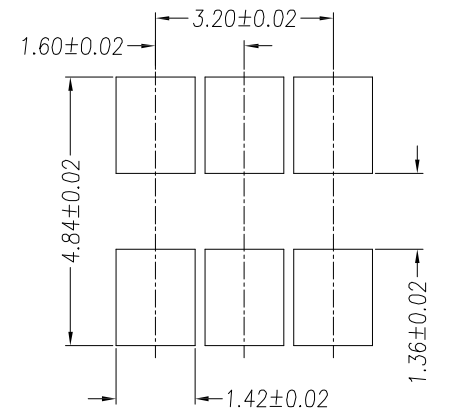

RECOMMENDED PATTERN FOR MATING

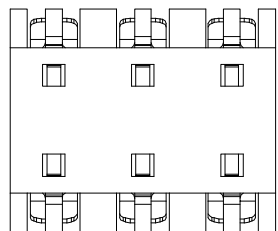

PRESSED TO 1.2mm HEIGHT

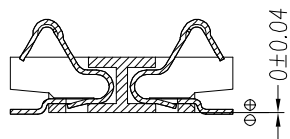
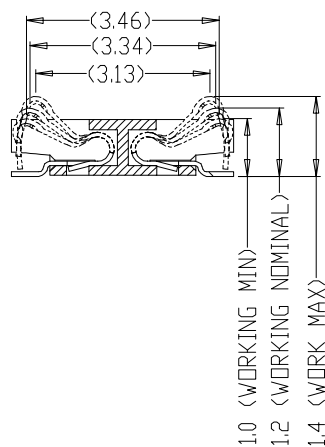

SECTION A-A

ITEM	DESCRIPTIONL	PART NUMBER	REMARK	Q'ty
1	TERMINAL	Ycut-FX-SH	80~120u" NICKEL PLATING OVER ALL; Au 3u" MIN PLATING ON CONTACT AREA; GOLD FLASH PLATING ON SOLDER AREA.	6
2	HOUSING	LCP 6807	HOUSING	1

GENERAL TOLERANCE		DWG NO.	JYSA1212-01	APPD:	WIND	Scale	1:1
X.±0.45	x.'±5'	Title	One Piece B to B P=1.60mm 6Pin Dual Rows S/T SMT H=1.0mm	CHKD:		UNIT	mm
.X±0.35	.x'±2'			DR:			
.XX±0.25	.xx'±1'	Part No.	JYS-BY100-219	Date	2018/02/29		
.XXX±0.15	.xxx'±0.5'						
SHEET	1/2			<b>JYSCONN</b> Shenzhen <b>JYSCONN Electronics Co., LTD.</b>			

REV.	ECN.NO.	MODIFY.CONTENT	DATE
A		NEW	2018/10/31

Trailer(160mm MIN)  
30 Empty Carrier Tape

Leader(100mm MIN)  
30 Empty Carrier Tape

Cover Tape(300mm MIN) Adhesive Tape

← Packaging Direction

→ User Direction of unreeling

载带说明:

- 1、载带材料: PS 透明防静电(静电压<100V)、厚度0.3 mm.
- 2、13英寸卷轮卷装长度: 24.48m.
- 3、13吋卷轮包装零件总颗数: 3060 PCS.
- 4、所有尺寸设计参照EIA-481-C-2003.

Cover Tape Peeling Angle: 165°~180°  
Peeling Force: 20~130g

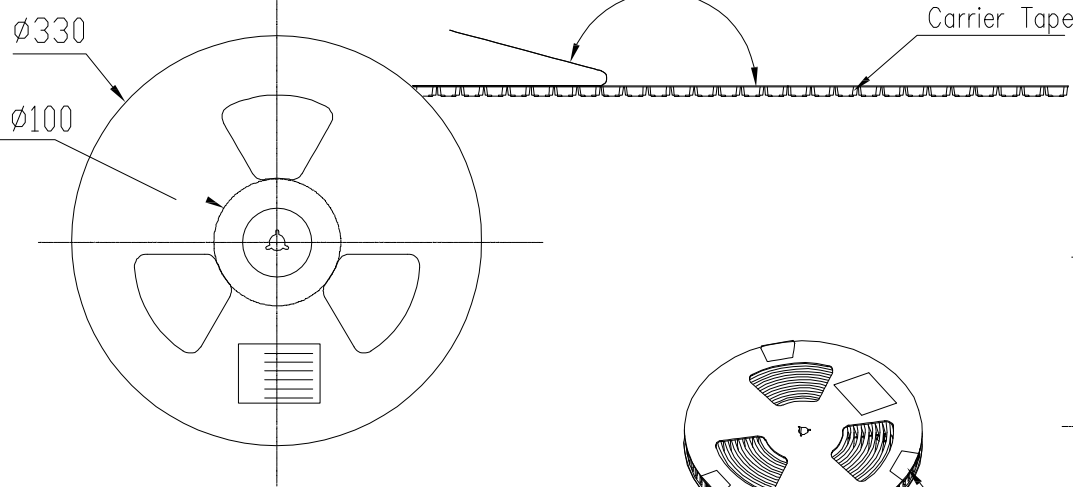

← Packaging Direction

→ User Direction of unreeling

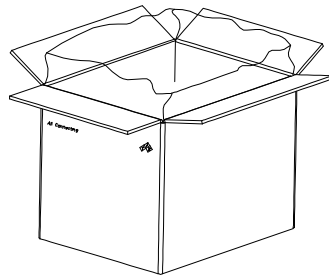
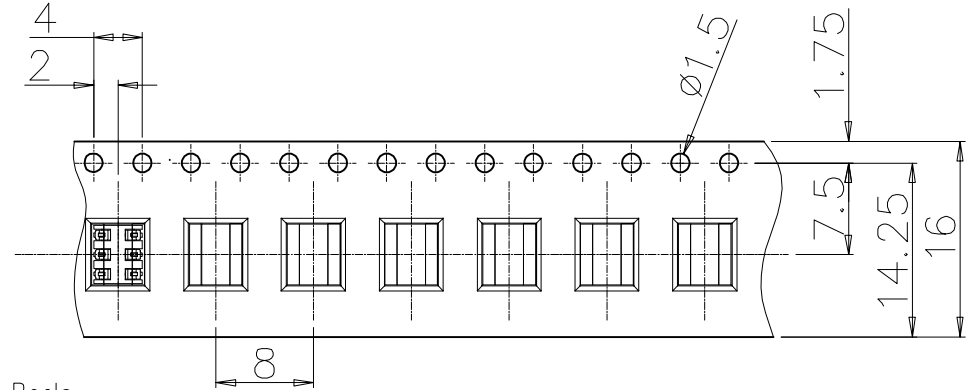

CARTON BOX

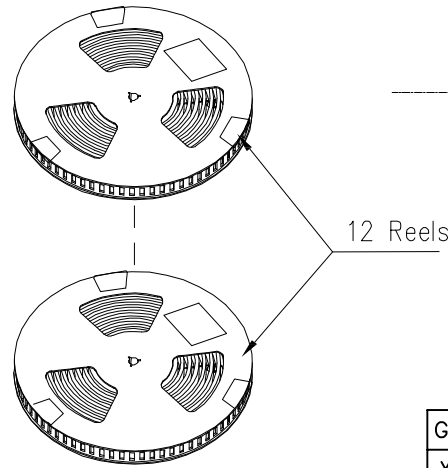

12 Reels

GENERAL TOLERANCE		DWG NO.	JYSA1212-01	APPD:	WIND	Scale	1:1
X.±0.45	x.±5°	Title	One Piece B to B P=1.60mm 6Pin Dual Rows S/T SMT H=1.0mm	CHKD:		UNIT	mm
.X±0.35	.x'±2°			DR:			
.XX±0.25	.xx'±1°	Part NO.	包装图	Date	2018/02/29		
.XXX±0.15	.xxx'±0.5°						
SHEET	2/2	<b>JYSCONN Electronics Co., LTD.</b>					

JYS180301001	JYS-BY100-219	3000	12	36000	345*345*255
载带料号	产品料号	QTY/REEL	REEL/CARTION	QTY/CARTION	CARTION SIZE